

Wetwall.



ACRYLIC INSTALLATION GUIDE

Contents

| | | |
|------|----------------------------------|----|
| 1.0 | Inspection | 3 |
| 2.0 | Storage | 3 |
| 3.0 | Handling | 3 |
| 4.0 | Planning & Preparation | 3 |
| 5.0 | Panels | 4 |
| 6.0 | Accessories | 4 |
| 7.0 | Tools & Fixings | 4 |
| 8.0 | Fitting Tips | 5 |
| 9.0 | Two Sided Shower Installation | 7 |
| 10.0 | Three Sided Shower Installation | 7 |
| 11.0 | Straight Jointing Details | 8 |
| 12.0 | Bottom & Skirting Details | 8 |
| 13.0 | Window, Door & Finishing Details | 9 |
| 14.0 | Kitchen Splashbacks | 9 |
| 15.0 | Cleaning | 11 |

1.0 Inspection

Panels must be thoroughly inspected upon receipt for damage or visible defects. The panels are supplied with a protective clear film to both the decorative face and the painted face, this should be peeled back to check for damage or discrepancies in colour* where necessary then replaced to provide protection during installation.

Do not install panels that you find to be defective.

Once the panels or profiles have been cut or installed we regard this as an acceptance of their quality and suitability for purpose and therefore we cannot accept any subsequent claims for faults or damage.

*colour discrepancies should be checked from the face side only as the appearance of 'patching' on the rear face is normal during the painting process.

2.0 Storage

Panels should always be stored flat to avoid bowing.

- Panels should never be stored outside.
- Stixall Neutral Cure Adhesive should be stored in cool dry conditions between 5 - 25°C.

3.0 Handling

Acrylic panels can have extremely sharp edges and we advise that suitable gloves be worn for protection when handling and installing them.

Extra care should be taken when handling, dry jointing and installing larger or shaped panels that have cut-outs in them as excessive flexing can cause cracking around the cut-outs.

4.0 Planning & Preparation

Before you undertake any type of installation it is always wise to carry out a degree of planning that might save you a lot of time and grief later on. Below are some points that may help.

4.1 Panel Lining Surface

Acrylic panels must be fitted to a continuous surface such as plaster board, existing tiling, chipboard & plywood sheathing and tile backers providing the surface it is sound, plumb and level. Some surfaces do require pre-treatment before installation, tiles should be de-greased and fresh plaster should be sealed with a proprietary PVA sealer.

It is important to ensure that there are no areas of wall to be clad where there are distinct differences in shading such as tape lines in plaster boarding as these can show through when installing lighter colours.

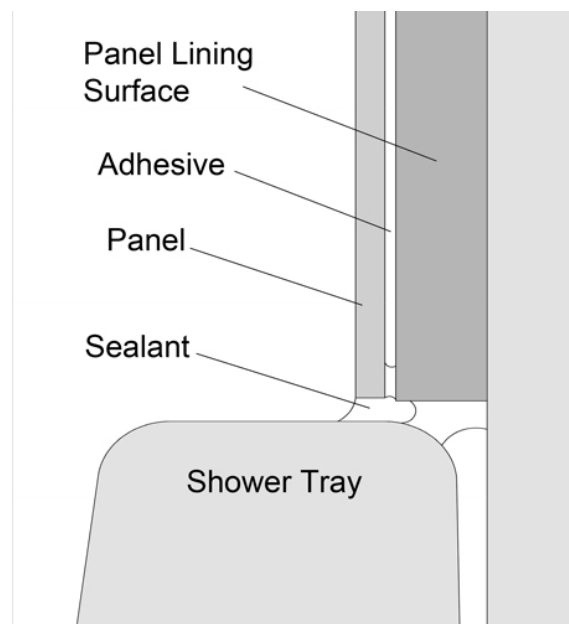

4.2 Services

Necessary pipe work should be fitted and short tails left where they are to pass through panels.

Electrical cabling should be in place and routed to avoid subsequent fixing points.

Shower trays and baths should be fitted in position, these should also be sealed in accordance with the manufacturers recommendations.

4.3 Allowances

The Acrylic panels are subject to expansion and contraction during normal use so it is necessary to make allowances for this during installation. If the profiles are not being used then a 3mm gap should be left between the edge of the panel and any adjoining surface, this gap should then be sealed with Wetwall silicone.

5.0 Panels

All panels are 4mm thick overall and are supplied with clear plastic protective films to both faces.

| | Width/Height | Weight (approx.) |
|--------------|---------------------|-------------------------|
| Shower Panel | 1220mm x 2440mm | 14.5Kg |
| Shower Panel | 900mm x 2440mm | 10.5Kg |
| Wall Panel | 600mm x 2440mm | 7.25Kg |

6.0 Accessories

Acrylic profiles come in 2440mm lengths and are available either colour co-ordinated to the acrylic or in a polished silver finish. It is recommended that Wetwall Silicone Sealant and Stixall Neutral Cure Adhesive is used for all installations.

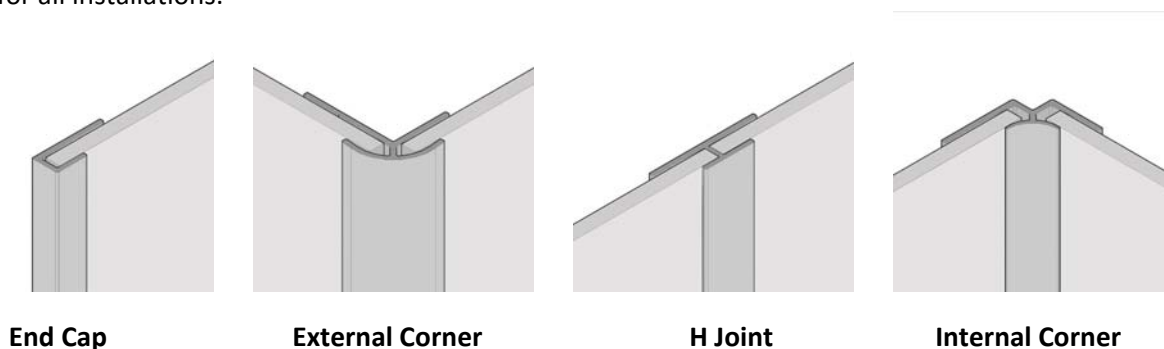

7.0 Tools & Fixings

Tools and fixings that you will need to install the panels include –

- **Jigsaw, circular saw or router**
- **Screwdriver**
- **Mastic Gun**
- **Measuring tape & pencil**
- **Masking Tape**
- **Neutral Cure Adhesive**
- **Silicone Sealant**

8.0 Fitting Tips

8.1 Sizing & Cutting

Before cutting you should make sure that you have taken into account any allowances for profiles that are to be used which are shown below.

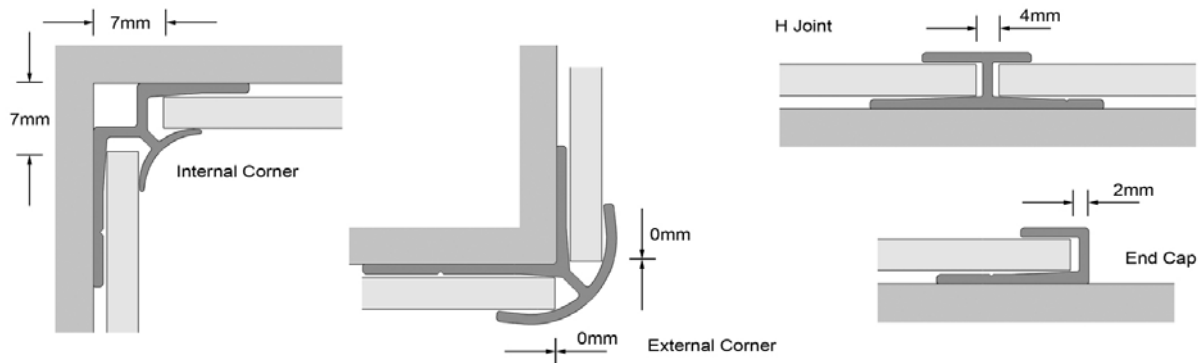

The

acrylic panels can be cut either using a circular saw, jigsaw or router. Whichever method is used, it is essential that the panel is face upwards, well supported and clamped in place to prevent chattering.

Top Tip: Applying masking tape to the soul plate of the saw or router can prevent scratching.

Circular Saw

Tungsten Carbide Tipped (TCT) blades that are designed for metals or plastics should be used as these will be fine toothed and give the best finish, the following recommendations should be followed –

| Clearance Angle γ | Rake Angle α | Cutting Speed | Circular Pitch t |
|--------------------------|---------------------|---------------|--------------------|
| 15-20° | 0-5° | 3000m/min | 10-20mm |

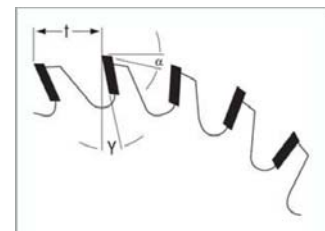

Jig Saw

Jigsaw blades that are specifically designed to cut Acrylic should be used such as the Bosch T101A or Makita A-85721 B-21 if these are not available then a fine toothed blade such as those designed to cut metals should be used. A high speed should be selected and the rotary action switched off.

Router

A straight TCT fluted cutter should be used with a cutting speed of 4500m/min

8.2 Drilling

Twist Drills

HSS twist drills specifically made for metals or plastics can be used and will have a point angle of between 60° - 90°. Standard drill bits which generally have a much flatter point angle can cause the acrylic to crack these drill bits can be re-sharpened to achieve this angle. When drilling a slow speed should be selected and the acrylic panel must be supported below.

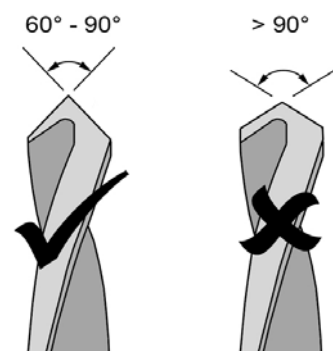

Hole Saws

Hole saws can be used to cut the Acrylic panels but must be the type designed to cut metal sheet and the pilot drill must have a point angle of between 60° - 90° as above.

The panel must be supported from behind and it is recommended to drill half way through the panel then turn over and finish the hole from the other side, this will prevent the edge from shattering. The edges of the hole should then be de-burred with 100 grit paper.

8.3 Cut-Outs

Shaped cut-outs can be formed by drilling 8mm diameter holes in the corners of the required shape and then cutting between using a jigsaw with an acrylic blade. It is important that the panel is supported at all times. With all cut outs a radius of at least 4mm must be left in the corners failure to do this can lead to the acrylic cracking.

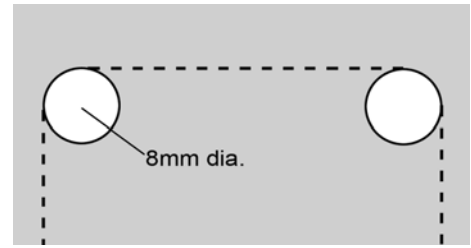

8.4 Edge Polishing

If the panel edge is to be left exposed, it can easily be finished to a polished glass like quality. Always peel back the protective film 25mm from the edge while polishing. Remove any sanding dust between grades immediately using a soft cloth.

Start with a 240 grit paper to remove any cutter marks from the machined edge, then process with a 400 grit paper and then finally a 600 grit. Chamfer any burrs or marks from the corners

8.5 Adhesive application

Only a Neutral Cure Clear adhesive such as Stixall should be used. Dry fitting should always be carried out before adhesive application.

Apply the adhesive in a minimum of 7mm diameter beads in vertical lines 100mm apart to the wall surface also ensure that beads applied around cut outs. Remove the clear protective film from the back of the panel to expose the painted surface before bonding.

Apply the panel to the wall within 30 minutes of adhesive application and using a straight edge apply even pressure to the surface to ensure a uniform finish.

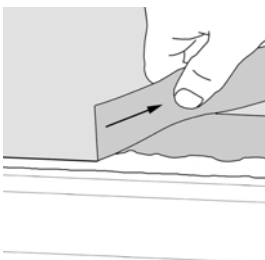
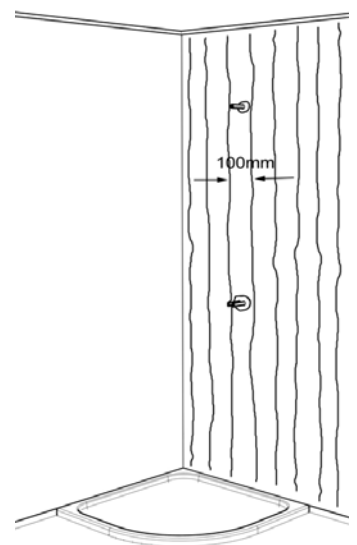

8.6 Masking

Preparing the panels with masking tape before sealing can save a lot of time cleaning off excess sealant later on in the installation, especially at the bottom joints where a larger covered seal will be formed.

8.7 Sealing at the bottom

A 3mm - 4mm gap must be left between the bottom of the panel and top of the shower tray or bath, this can be achieved by using packers when fixing panels. The gaps should then be sealed ensuring that the silicone is forced into the void.

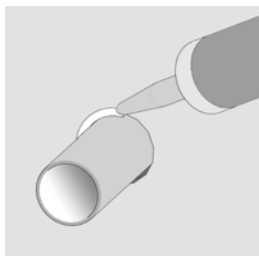
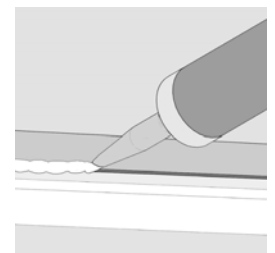

8.8 Sealing at apertures & Cut-outs

A clearance gap of 2-3mm all around should be allowed where pipes or fittings come through the panel even where collars are to be fitted. The gap should then be filled with sealant.

8.9 Fitting through Acrylic Panels

Fittings such as shower attachments, screens, towel rails, etc. can be fixed directly through the panels using suitable fixings. Heavy items will need solid fixing points behind the panels to provide the necessary support, these should be considered when planning your installation.



9.0 Two Sided Shower Installation – Steps

The following steps assume that the panel lining surface has been prepared and the panels and trims have been cut to the required size and that they have been dry fitted to check assembly.

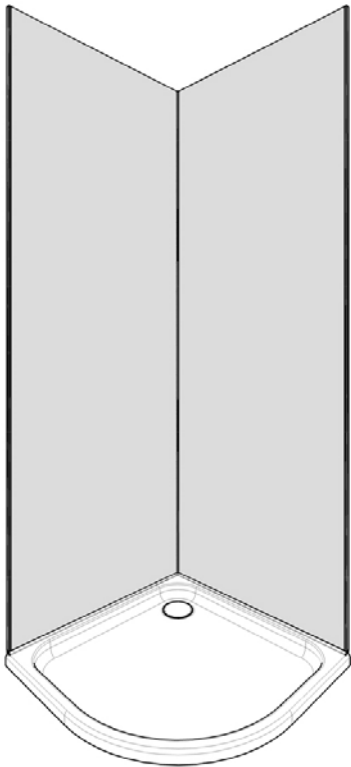

1. Remove the protective film from the reverse of the first panel and peel back the protective film about 25mm from the front edge.
2. Apply a bead of sealant into one side of the internal corner profile and fit onto the exposed edge of the first panel.
3. Repeat this on the opposite edge if an End Cap profile is required and fit the End Cap to the edge of the panel using a bead of sealant.
4. A 3-4mm gap should be left between the bottom of the panel and the top of the shower tray or bath, this can be achieved by using packers which will be removed before sealing.
5. Apply adhesive to the wall as detailed in Fitting Tips then position the panel against the wall applying even pressure over the surface to ensure a good bond.
6. Repeat steps 2-5 for the second panel.
7. Seal the bottom of the panels and any apertures required as detailed in the fitting tips section.

10.0 Three Sided Shower Installation – Steps

The following steps assume that the panel lining surface has been prepared and the panels and trims have been cut to the required size and that they have been dry fitted to check assembly.

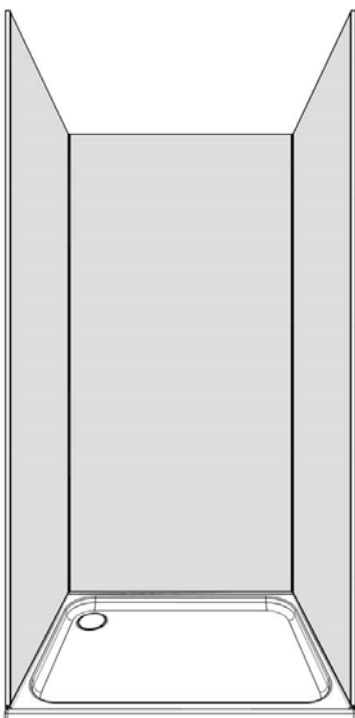

1. Remove the protective film from the reverse of the back panel and peel back the protective film about 25mm from both the front edges.
2. Fit both of the internal corner profiles to the edge of the panel by applying a bead of sealant into one channel of each of the profiles.
3. A 3-4mm gap should be left between the bottom of the panel and the top of the shower tray or bath, this can be achieved by using packers which will be removed before sealing.
4. Apply adhesive to the wall as detailed in Fitting Tips then position the panel against the wall applying even pressure over the surface to ensure a good bond.
5. Peel back the protective film about 25mm from the vertical edge of the side panel.

6. Repeat this on the opposite edge if an End Cap profile is required and fit the End Cap to the edge of the panel using a bead of sealant.
7. Apply adhesive to the side wall as detailed in Fitting Tips.
8. Apply a bead of sealant into the remaining channel of the Internal Corner profile.
9. Insert the exposed edge of the side panel into the internal corner at an angle ensuring that a good seal is achieved then swing the panel back into place against the side wall applying even pressure over the surface to ensure a good bond.
10. Repeat steps 5-9 for the remaining side panel.
11. Seal the bottom of the panels and any apertures required as detailed in the fitting tips section.

11.0 Straight Jointing Details

When panelling areas more than 1200mm wide we would recommend using an H section Profile between the panels as this will ensure a more robust seal.

Ensure that sealant is applied into each of the channels and that Stixall Neutral Cure Adhesive is applied to the back of the profile when fitting.

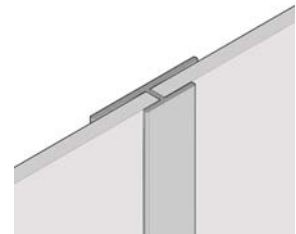

12.0 Bottom & Skirting Details

Depending on the type of installation there can be various options for finishing the bottom of the panel but in all cases it is essential that they are sealed adequately.

If the panels are being fitted above a bath or a shower tray, then these should be fitted first and sealed in accordance with the manufacturer's recommendations.

The panel lining surface should then be installed to provide the necessary step to allow the acrylic panel to be fitted 3-4mm above the horizontal face of the shower tray or bath. This gap should then be sealed ensuring that the silicone is forced into the void.

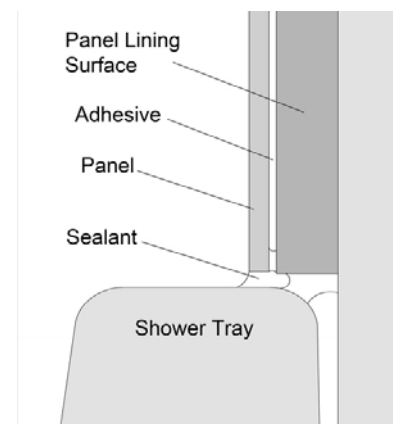

In wet areas we do not recommend that the panels are fitted right down to the floor as sealing the joint can be extremely difficult.

A coved tile or PVC skirting is the preferred option with the panels fitted 3-4mm above. This gap should then be sealed ensuring that the silicone is forced into the void.

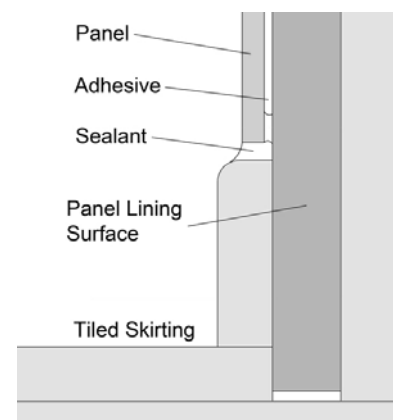

13.0 Window, Door & Finishing Details

There are various ways of finishing the panelling around windows and doors which will depend on the surface the panels have been fixed to, the window or door framing detail and the look you prefer.

Edges can simply be silicone sealed into existing frames or capped off with profiles. Corner joints can be formed using End Caps or by simply polishing the exposed edges of the acrylic panel.

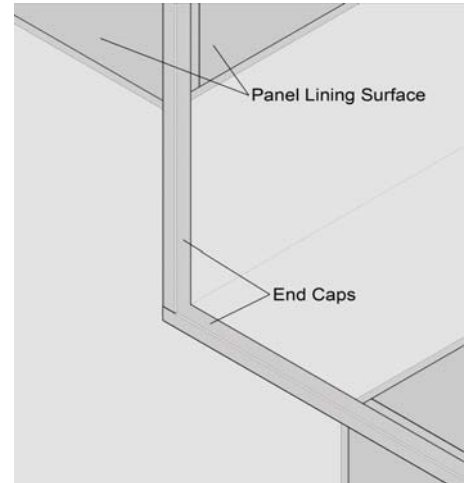
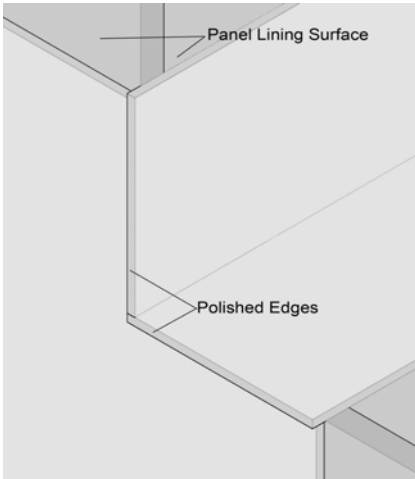

14.0 Kitchen Splashbacks

Acrylic panels can be installed all around the kitchen as an easy to clean low maintenance splashback.

The basic installation instructions for cutting, drilling and sealing the acrylic panels should be followed as detailed in the Fitting Tips section.

Allowances also need to be made for expansion and contraction and a 3mm gap should be left between the edge of the panels and any adjoining surface, this gap should then be sealed with Wetwall silicone.

The Acrylic panels are classed as a flammable material and as such should not be installed behind open flame appliances. Care should be taken to avoid direct contact of hot cookware such as Woks or saucepans for any period of time.

Both electric and gas hob rings produce much higher levels of radiant heat when they are exposed, this should be avoided as much as possible and they should not be left on when not covered by cookware. The panels should not be exposed to radiant heat exceeding 118°C as this can cause permanent damage or discolouration and will invalidate the warranty.

The acrylic panels can installed directly behind most cooking appliances providing the following installation instructions are followed.

14.1 Adhesive Application

With all the Acrylic panels the adhesive should be applied in minimum 7mm diameter vertical beads spaced 100mm apart. The area directly behind the hob should also have additional 7mm diameter vertical beads spaced 20mm apart and at least 300mm high, when the panel is bonded to the wall using a straight edge with evenly applied pressure this will form a continuous area of adhesion with little or no air gaps providing enhanced heat dispersion.

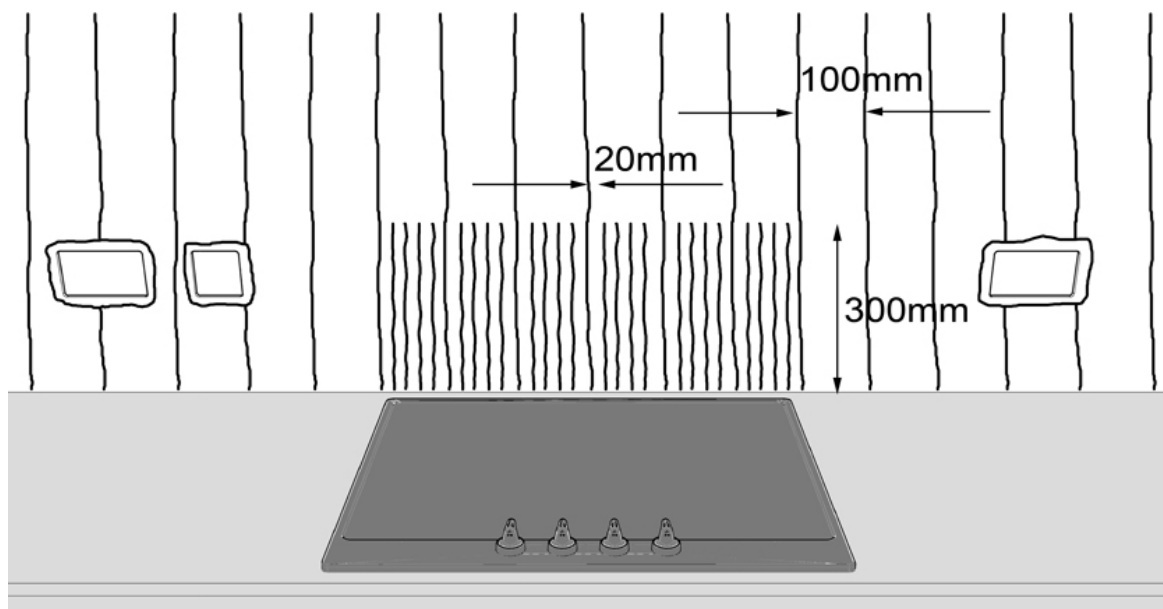

Also ensure that all cut-outs have a 7mm diameter bead of adhesive applied approximately 15mm in from the edges.

14.2 Gas, Induction, Electric and Ceramic Hobs

A minimum gap of 50mm should be allowed between the back of the hob and the face of the Acrylic Panel.

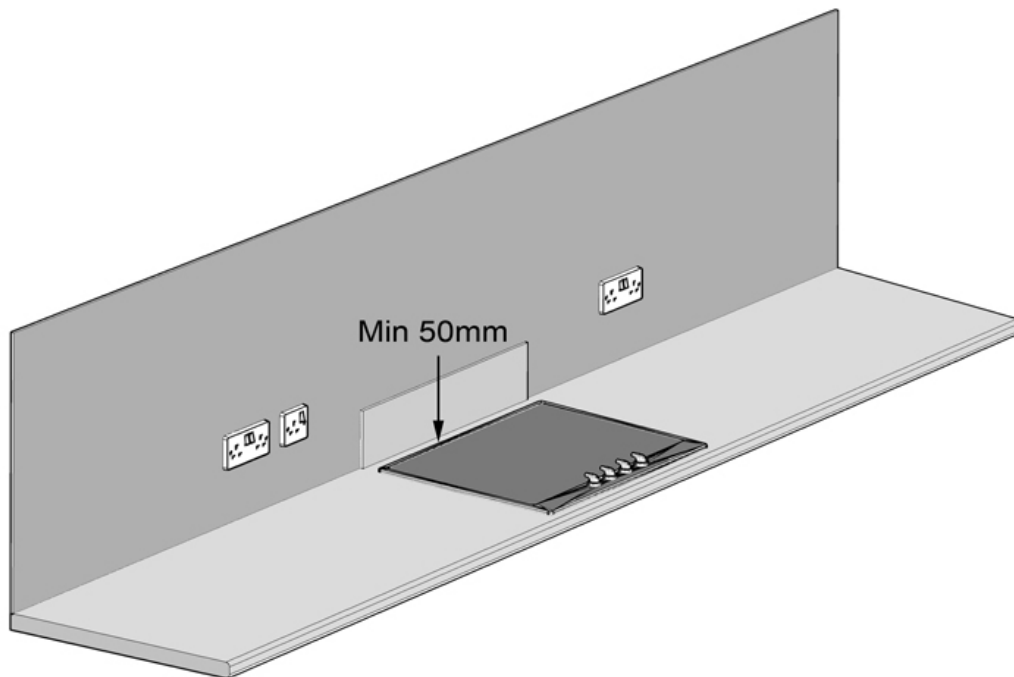

A colour coordinated glass 200mm high upstand must be fitted onto the face of the Acrylic splashback directly behind the hob.

The glass upstand should be fixed using Stixall Neutral Cure Adhesive applied around the perimeter in a 7mm diameter bead approximately 10mm in from the edge.

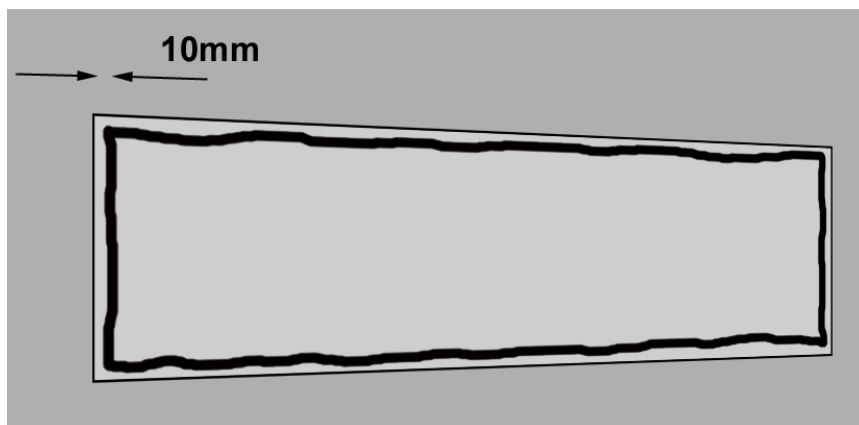

15.0 Cleaning

The panels can easily be kept clean with warm water and a very mild detergent. Where there are more stubborn stains, please contact the manufacturer's agent for more specific advice.

Under no circumstance should you clean your panels with an abrasive cleaner or any other abrasive material.

Shore Laminates Limited
Friarton Bridge Park
Perth
PH2 8DD

t. 01738 634455
f. 01738 441622
e. sales@shorelamiantes.com